



Pigra Comercial Group S.A. de C.V.



## PIG2510X05L(M)(H) PIG2510X12L(M)(H)

### Features

Size: 25×25×10mm(1.0×1.0×0.40in)

Frame/Impeller: Reinforced Plastic UL94V-0

Bearings: Ball Bearing&Sleeve Bearing

Life Expectancy: 50,000 Hours at 20°C-Ball  
30,000 Hours at 20°C-Sleeve

Approvals: UL CUL TUV CE RoHS

Weight: 7g

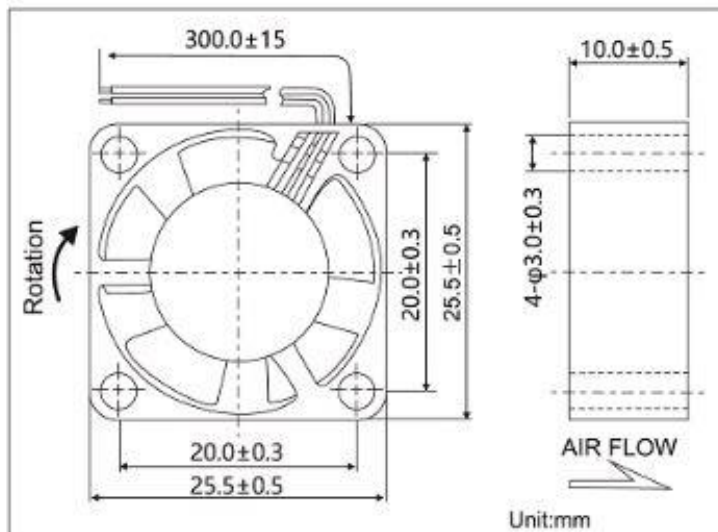

### Air Flow vs Air Pressure

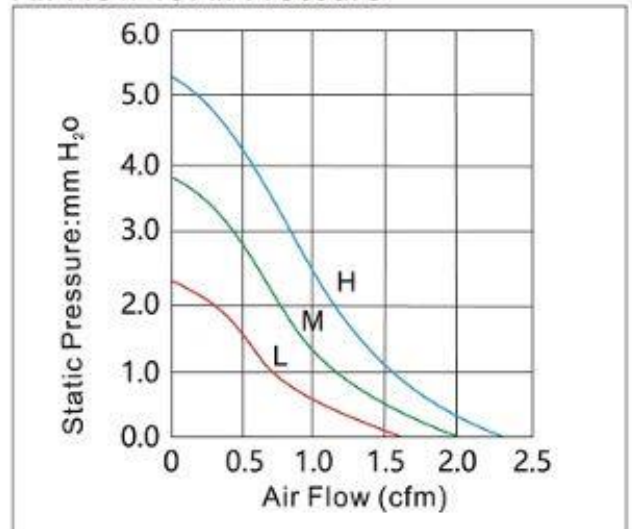

### Performance

Model	Bearing System X			Rated Voltage (V)	Current (A)	Input Power (W)	Nominal Speed (R.P.M)	Air Flow (CFM)	Air Pressure (mm-H <sub>2</sub> O)	Noise (dBA)
	S	B	D							
PIG2510X05L	✓	✓	✓	5	0.12	0.60	8000	1.57	2.17	18
PIG2510X05M	✓	✓	✓	5	0.18	0.90	10000	2.00	3.88	21
PIG2510X05H	✓	✓	✓	5	0.22	1.10	12000	2.36	5.25	23
PIG2510X12L	✓	✓	✓	12	0.08	0.96	8000	1.57	2.17	18
PIG2510X12M	✓	✓	✓	12	0.10	1.20	10000	2.00	3.88	21
PIG2510X12H	✓	✓	✓	12	0.12	1.44	12000	2.36	5.25	23