



Pigra Comercial Group S.A. de C.V.



PIG5010X05L(M)(H)

PIG5010X12L(M)(H)

PIG5010X24L(M)(H)

Features

Size: 50×50×10mm(1.97×1.97×0.39in)
 Frame/Impeller: Reinforced Plastic UL94V-0
 Bearings: Ball Bearing&Sleeve Bearing
 Life Expectancy: 50,000 Hours at 20°C-Ball
 30,000 Hours at 20°C-Sleeve
 Approvals: UL CUL TUV CE RoHS
 Weight: 18g

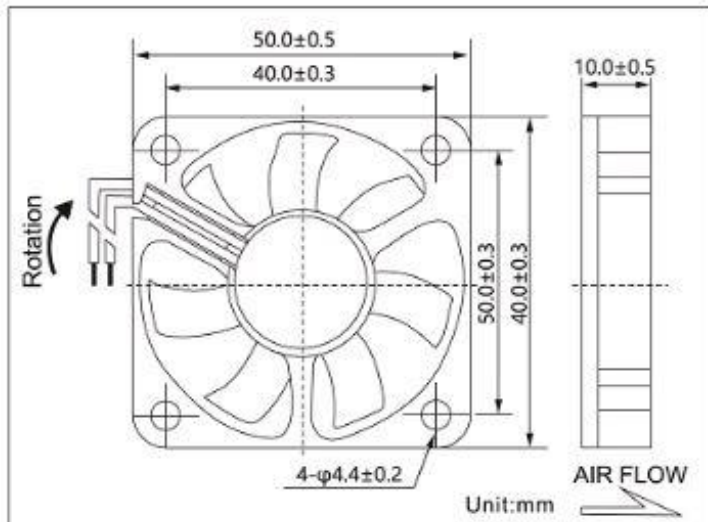

Air Flow vs Air Pressure

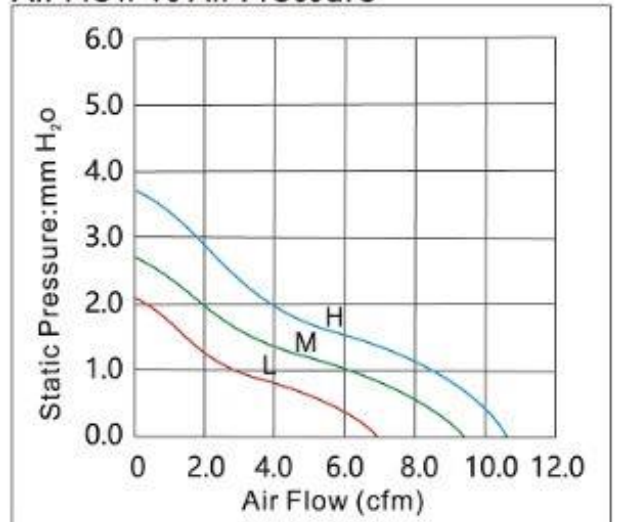

Performance

Model	Bearing System X			Rated Voltage (V)	Current (A)	Input Power (W)	Nominal Speed (R.P.M)	Air Flow (CFM)	Air Pressure (mm-H ₂ O)	Noise (dBA)
	S	B	D							
PIG5010X05L	✓	✓	✓	5	0.15	0.75	4000	7.20	2.02	21
PIG5010X05M	✓	✓	✓	5	0.20	1.00	5000	9.15	2.75	27
PIG5010X05H	✓	✓	✓	5	0.25	1.25	6000	10.20	3.65	33
PIG5010X12L	✓	✓	✓	12	0.08	0.96	4000	7.20	2.02	21
PIG5010X12M	✓	✓	✓	12	0.10	1.20	5000	9.15	2.75	27
PIG5010X12H	✓	✓	✓	12	0.12	1.44	6000	10.20	3.65	33
PIG5010X24L	✓	✓	✓	24	0.05	1.20	4000	7.20	2.02	21
PIG5010X24M	✓	✓	✓	24	0.07	1.68	5000	9.15	2.75	27
PIG5010X24H	✓	✓	✓	24	0.09	2.16	6000	10.20	3.65	33