



Pigra Comercial Group S.A. de C.V.



PIG5015X05L(M)(H)
PIG5015X12L(M)(H)
PIG5015X24L(M)(H)

Features

Size: 50×50×15mm(1.97×1.97×0.59in)
 Frame/Impeller: Reinforced Plastic UL94V-0
 Bearings: Ball Bearing&Sleeve Bearing
 Life Expectancy: 50,000 Hours at 20°C-Ball
 30,000 Hours at 20°C-Sleeve
 Approvals: UL CUL TUV CE RoHS
 Weight: 25g

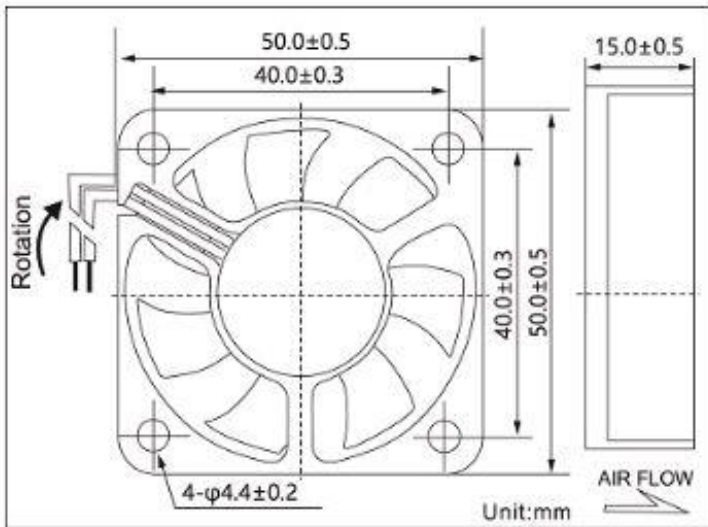

Air Flow vs Air Pressure

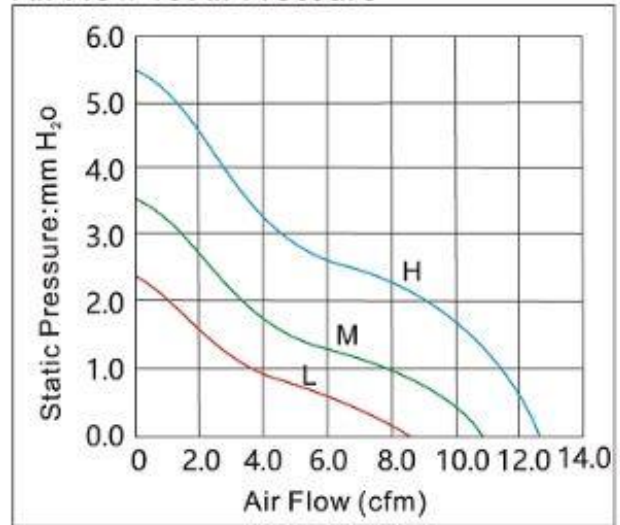

Performance

Model	Bearing System X			Rated Voltage (V)	Current (A)	Input Power (W)	Nominal Speed (R.P.M)	Air Flow (CFM)	Air Pressure (mm-H ₂ O)	Noise (dBA)
	S	B	D							
PIG5015X05L	✓	✓	✓	5	0.22	1.10	4000	8.25	2.30	26
PIG5015X05M	✓	✓	✓	5	0.25	1.27	5000	10.20	3.65	32
PIG5015X05H	✓	✓	✓	5	0.28	1.40	6000	12.25	5.43	35
PIG5015X12L	✓	✓	✓	12	0.10	1.20	4000	8.25	2.30	26
PIG5015X12M	✓	✓	✓	12	0.13	1.56	5000	10.20	3.65	32
PIG5015X12H	✓	✓	✓	12	0.15	1.80	6000	12.25	5.43	35
PIG5015X24L	✓	✓	✓	24	0.06	1.44	4000	8.25	2.30	26
PIG5015X24M	✓	✓	✓	24	0.08	1.92	5000	10.20	3.65	32
PIG5015X24H	✓	✓	✓	24	0.10	2.40	6000	12.25	5.43	35